

# SERVICE MANUAL

INTEGRATED STEREO  
AMPLIFIER

## SANSUI A-700

(Silver & Black Model)

## SANSUI A-730

CLASSIQUE A-730

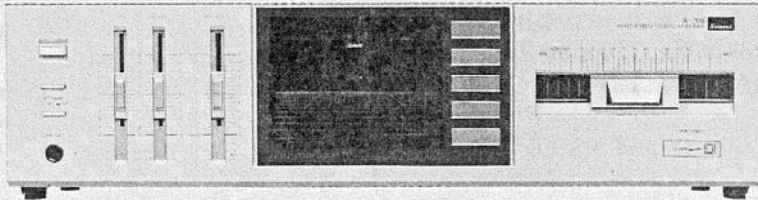

### CAUTION

1. Parts identified by the  $\Delta$  symbol on the schematic diagram and the parts list are critical for safety. Use only replacement parts that have critical characteristics recommended by the manufacturer.
2. Make leakage-current or resistance measurements to determine that exposed parts are acceptably insulated from the supply circuit before returning the appliance to the customer.



SANSUI ELECTRIC CO., LTD.

A-700/A-730  
CLASSIQUE A-730

### •SPECIFICATIONS

#### Power output

Min. RMS, both channels driven, from 20 to 20,000 Hz,  
with no more than 0.06% total harmonic distortion  
55 watts per channel into 8 ohms

Load impedance..... 8 ohms

#### Total harmonic distortion

..... less than 0.06% at or below  
rated min. RMS power output

#### Frequency response (at 1 watt)

..... 5 to 60,000 Hz  
+1 dB, -2 dB

#### RIAA curve deviation (PHONO, 20 Hz to 20 kHz)

..... +0.5 dB, -0.5 dB

#### Input sensitivity and impedance

(1 kHz, for rated power output)

PHONO..... 2.5 mV/47 kilohms  
(Max. input capability; 120mV at 1 kHz, less than  
0.1% total harmonic distortion)

TUNER, TAPE PLAY.... 150 mV/47 kilohms

#### Output level (1 kHz)

TAPE REC..... 130 mV into 47 kilohms

#### Signal to noise ratio (short-circuit, A-network)

PHONO..... 72 dB

TUNER, TAPE PLAY.... 95 dB

#### Power requirements

Power voltage..... 120/220/240V (50/60 Hz)  
For U.S.A. & Canada

..... 120V (60 Hz)

Power consumption.... 205 watts 245 VA Rated

300 watts Maximum

#### Dimensions..... 430 mm (16-15/16") W

112 mm (4-7/16") H

230 mm (9-1/16") D

#### Weight..... 5.2 kg (11.5 lbs.) net

5.8 kg (12.8 lbs.) packed

\* Design and specifications subject to changes without notice for improvements.

## CAUTION

1. The symbols, UL, CSA, SA, BS, UK, EU, AS, XX <EXPORT> and XX-V <EXPORT(V)> on the parts list and the schematic diagram mean followings respectively.  
UL..... Manufactured for U.S.A market.  
(Underwriters Laboratories approved model.)  
CSA ..... Manufactured for Canadian market.  
SA..... Manufactured for South African market.  
BS, UK..... Manufactured for United Kingdom market.  
EU ..... Manufactured for European market.  
AS..... Manufactured for Australian market.  
XX <EXPORT> ..... Standard Version with Inner Voltage Selector.  
XX-V <EXPORT(V)> .... Standard Version with Outer Voltage Selector.  
NON MARK ..... Common Parts.
2. Some printed circuit boards are not supplied as the assembled.  
To separate these in this service manual, the stock No's are not indicated at the ends of the board names. However, the individual parts on the circuit boards are provided by orders.
3. Since some of capacitors and resistors are omitted from parts lists in this service manual, refer to the Common Parts List for capacitors & resistors, which was issued on February 1983.
4. Abbreviations in this service manual are as follows.

### •Abbreviations List

C.R.	: Carbon Resistor	E.B.L.	: Low Leak Bi-Polar Electrolytic Capacitor
S.R.	: Solid Resistor	Ta.C.	: Tantalum Capacitor
Ce.R.	: Cement Resistor	F.C.	: Film Capacitor
M.R.	: Metal Film Resistor	M.P.	: Metalized Paper Capacitor
F.R.	: Fusing Resistor	P.C.	: Polystyrene Capacitor
N.I.R.	: Non-Inflammable Resistor	G.C.	: Gimmic Capacitor
A.R.	: Array Resistor	A.C.	: Array Capacitor
C.C.	: Ceramic Capacitor	V.R.	: Variable Resistor
C.T.	: Ceramic Capacitor, Temperature Compensation	S.V.R.	: Semi Variable Resistor
E.C.	: Electrolytic Capacitor	SW.	: Switch
E.L.	: Low Leak Electrolytic Capacitor	Chip R.	: Chip Resistor
E.B.	: Bi-Polar Electrolytic Capacitor	Chip C.	: Chip Capacitor



# 1. BLOCK DIAGRAM

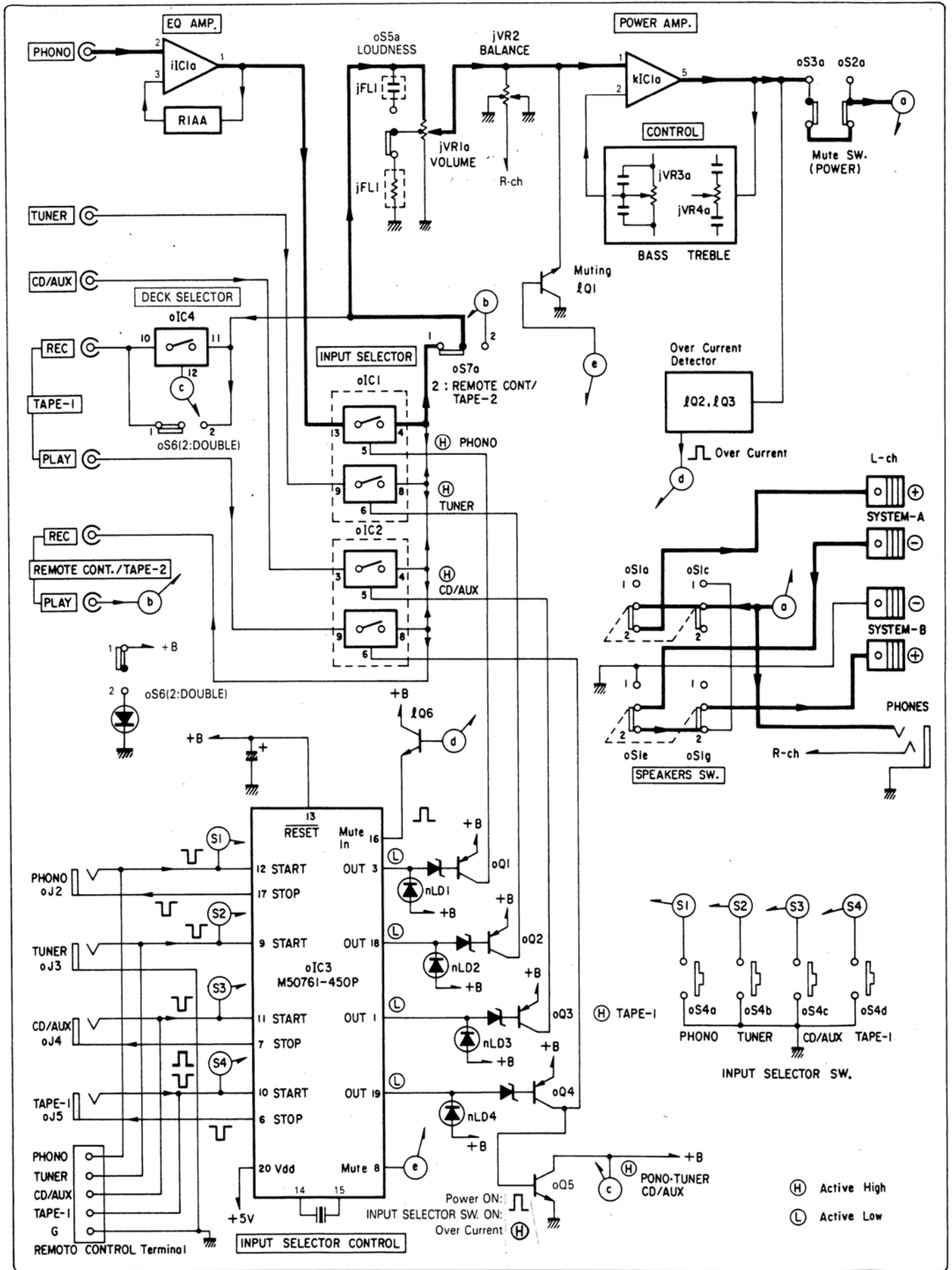

## 2. PARTS LOCATION & PARTS LIST

### 2-1. F-4759 Equalizer Amp. Board (Stock No. 00852601)

Component Side

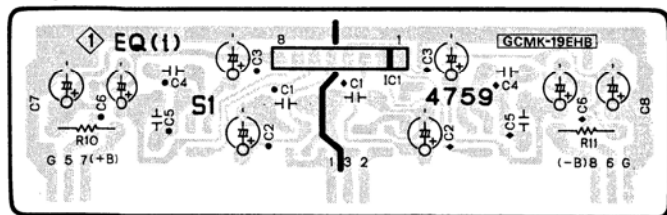

Pattern Side <Chip Parts>

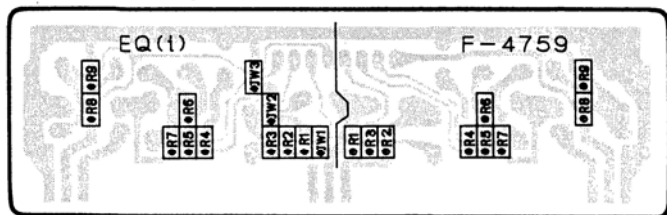

•Note: On this circuit board, the left channel is specified by "●" mark on top of the parts No.

#### Parts List

Parts No.	Stock No.	Description
•IC		
iC1	46078900	M5218L
iJW1	46741100	Cross Conductor (Chip)
iJW2	46741100	Cross Conductor (Chip)
iJW3	46741100	Cross Conductor (Chip)
iR1	46752400	100kΩ 1/8W Chip R.
iR2	46746800	470Ω 1/8W Chip R.
iR3	46752400	100kΩ 1/8W Chip R.
iR4	46746900	510Ω 1/8W Chip R.
iR5	46746900	510Ω 1/8W Chip R.
iR6	46750800	22kΩ 1/8W Chip R.
iR7	46753500	300kΩ 1/8W Chip R.
iR8	46746800	470Ω 1/8W Chip R.
iR9	46752400	100kΩ 1/8W Chip R.
△iR10	46229000	100Ω 1/2W N.I.R.
△iR11	46229000	100Ω 1/2W N.I.R.
iC4	46282400	3300pF 50V F.C.
iC5	46283000	0.012μF 50V F.C.

### 2-2. F-4761 Tone Control Board

Component Side

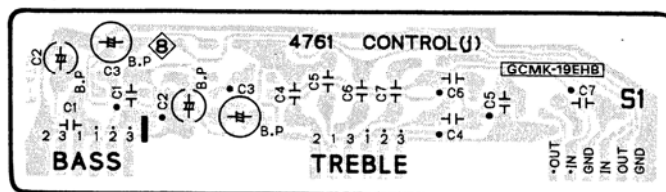

Pattern Side <Chip Parts>

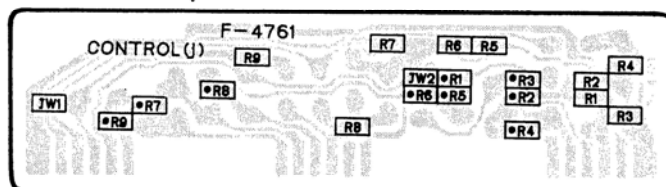

•Note: On this circuit board, the left channel is specified by "●" mark on top of the parts No.

#### Parts List

Parts No.	Stock No.	Description
iJW1	46741100	Cross Conductor (Chip)
iJW2	46741100	Cross Conductor (Chip)
iR1	46750200	12kΩ 1/8W Chip R.
iR2	46748200	1.8kΩ 1/8W Chip R.
iR3	46753400	270kΩ 1/8W Chip R.
iR4	46751000	27kΩ 1/8W Chip R.
iR5	46751700	51kΩ 1/8W Chip R.
iR6	46748400	2.2kΩ 1/8W Chip R.
iR7	46749400	5.6kΩ 1/8W Chip R.
iR8	46749600	6.8kΩ 1/8W Chip R.
iR9	46747200	680Ω 1/8W Chip R.
iC1	46283600	0.039μF 50V F.C.
iC2	46937000	0.22μF 50V E.B.
iC3	48101800	47μF 10V E.B.
iC4	46281800	1000pF 50V F.C.
iC5	46282800	8200pF 50V F.C.
iC6	46282700	6800pF 50V F.C.

### 2-3. F-4764 Power Amp. Sub Board (Stock No. 00867601)

Component Side

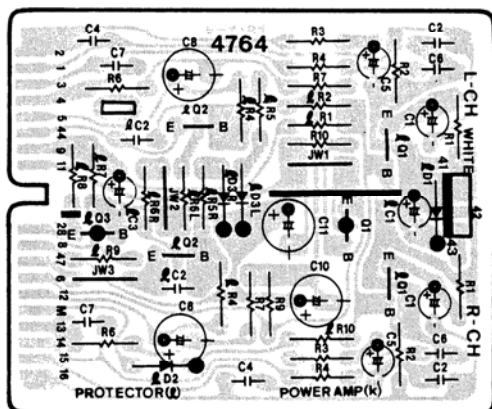

#### Parts List

Parts No.	Stock No.	Description
•Transistor		
kQ1	46581601	2SA992
	or 46614001	2SA1283
	or 46947301	2SA1049

Parts No.	Stock No.	Description
△kR9	46229000	100Ω 1/2W N.I.R.
iQ1	46367101	2SC2603
	or 46367301	2SC2458
	or 46392101	2SC2785
iQ2	46367101	2SC2603
	or 46367301	2SC2458
	or 46391901	2SC2785
iQ3	46581601	2SA992
	or 46614001	2SA1283
	or 46947301	2SA1049
•Diode		
iD1	03117600	1S2473T77
	or 46086000	1S1588TP-3
iD2	03117600	1S2473T77
	or 46086000	1S1588TP-3
iD3	03117600	1S2473T77
	or 46086000	1S1588TP-3
iC2	46284100	0.1μF 50V F.C.

**2-4. F-4766 INPUT SELECTOR Control Board**  
Component Side (Stock No. 00867701)

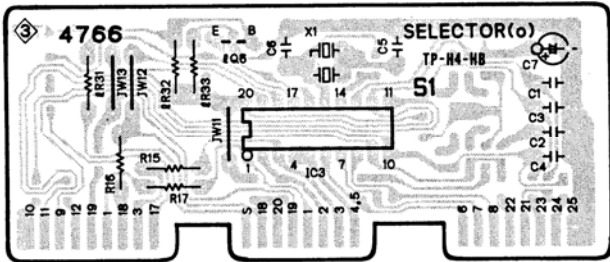

Pattern Side < Chip Parts >

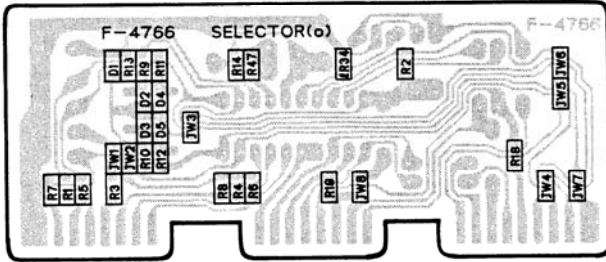

**Parts List**

Parts No.	Stock No.	Description
• Transistor		
oQ6	46367101 or 46367301 or 46391901	2SC2603 2SC2458 2SC2785
IR34	46749200	4.7kΩ 1/8W Chip R.
• IC		
oIC3	48158300	M50761-450P
oX01	46396200	Ceramic Element CSB400P
• Diode		
oD1	46852000	RLS-73 (Chip)
oD2	46852000	RLS-73 (Chip)
oD3	46852000	RLS-73 (Chip)
oD4	46852000	RLS-73 (Chip)
oD5	46852000	RLS-73 (Chip)
oJW1 ~ 8	46741100	Cross Conductor (Chip)
oR1	46748000	1.5kΩ 1/8W Chip R.
oR2	46748000	1.5kΩ 1/8W Chip R.
oR3	46748000	1.5kΩ 1/8W Chip R.
oR4	46748000	1.5kΩ 1/8W Chip R.
oR5	46748000	1.5kΩ 1/8W Chip R.
oR6	46748000	1.5kΩ 1/8W Chip R.
oR7	46748000	1.5kΩ 1/8W Chip R.
oR8	46748000	1.5kΩ 1/8W Chip R.
oR9	46750000	10kΩ 1/8W Chip R.
oR10	46750000	10kΩ 1/8W Chip R.
oR11	46750000	10kΩ 1/8W Chip R.
oR12	46750000	10kΩ 1/8W Chip R.
oR13	46752400	100kΩ 1/8W Chip R.
oR14	46754800	1MΩ 1/8W Chip R.
oR18	46746600	390Ω 1/8W Chip R.
oR19	46751800	56kΩ 1/8W Chip R.
oR47	46748700	3kΩ 1/8W Chip R.

**2-5. F-4767 INPUT SELECTOR Board**  
Component Side (Stock No. 00867801)

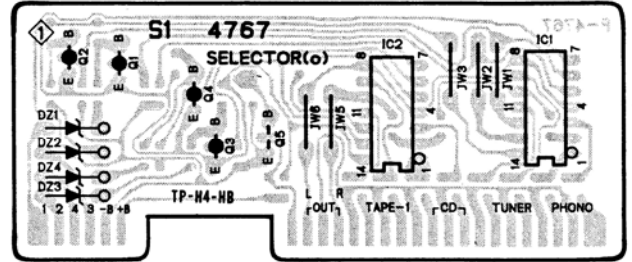

Pattern Side < Chip Parts >

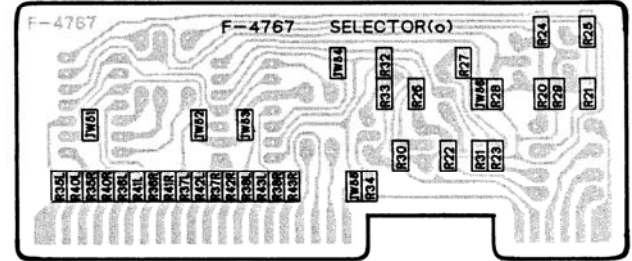

**Parts List**

Parts No.	Stock No.	Description
• Transistor		
oQ1	46188601 or 46367001 or 46367201	2SA1015 2SA1115 2SA1048
oQ2	46188601 or 46367001 or 46367201	2SA1015 2SA1115 2SA1048
oQ3	46188601 or 46367001 or 46367201	2SA1015 2SA1115 2SA1048
oQ4	46188601 or 46367001 or 46367201	2SA1015 2SA1115 2SA1048
oQ5	46188701 or 46367101 or 46367301	2SC1815 2SC2603 2SC2458
• IC		
oIC1	46255000 or 48056800	LC4066BH LC4966
oIC2	46255000 or 48056800	LC4066BH LC4966
• Zener Diode		
oDZ1	46112700	05Z8.2-Y
oDZ2	46112700	05Z8.2-Y
oDZ3	46112700	05Z8.2-Y
oDZ4	46112700	05Z8.2-Y
oJW51 ~ 56	46741100	Cross Conductor (Chip)
oR20	46747200	680Ω 1/8W Chip R.
oR21	46747200	680Ω 1/8W Chip R.
oR22	46747200	680Ω 1/8W Chip R.
oR23	46747200	680Ω 1/8W Chip R.
oR24	46749200	4.7kΩ 1/8W Chip R.
oR25	46749200	4.7kΩ 1/8W Chip R.
oR26	46749200	4.7kΩ 1/8W Chip R.
oR27	46749200	4.7kΩ 1/8W Chip R.
oR28	46751600	47kΩ 1/8W Chip R.
oR29	46751600	47kΩ 1/8W Chip R.
oR30	46751600	47kΩ 1/8W Chip R.
oR31	46751600	47kΩ 1/8W Chip R.
oR32	46750800	22kΩ 1/8W Chip R.
oR33	46749200	4.7kΩ 1/8W Chip R.
oR34	46751600	47kΩ 1/8W Chip R.
oR35	46749200	4.7kΩ 1/8W Chip R.
oR36	46749200	4.7kΩ 1/8W Chip R.
oR37	46749200	4.7kΩ 1/8W Chip R.
oR38	46749200	4.7kΩ 1/8W Chip R.
oR40	46754000	470kΩ 1/8W Chip R.
oR41	46754000	470kΩ 1/8W Chip R.
oR42	46754000	470kΩ 1/8W Chip R.
oR43	46754000	470kΩ 1/8W Chip R.

## 2-6. F-4769 Input Terminal Board

Component Side

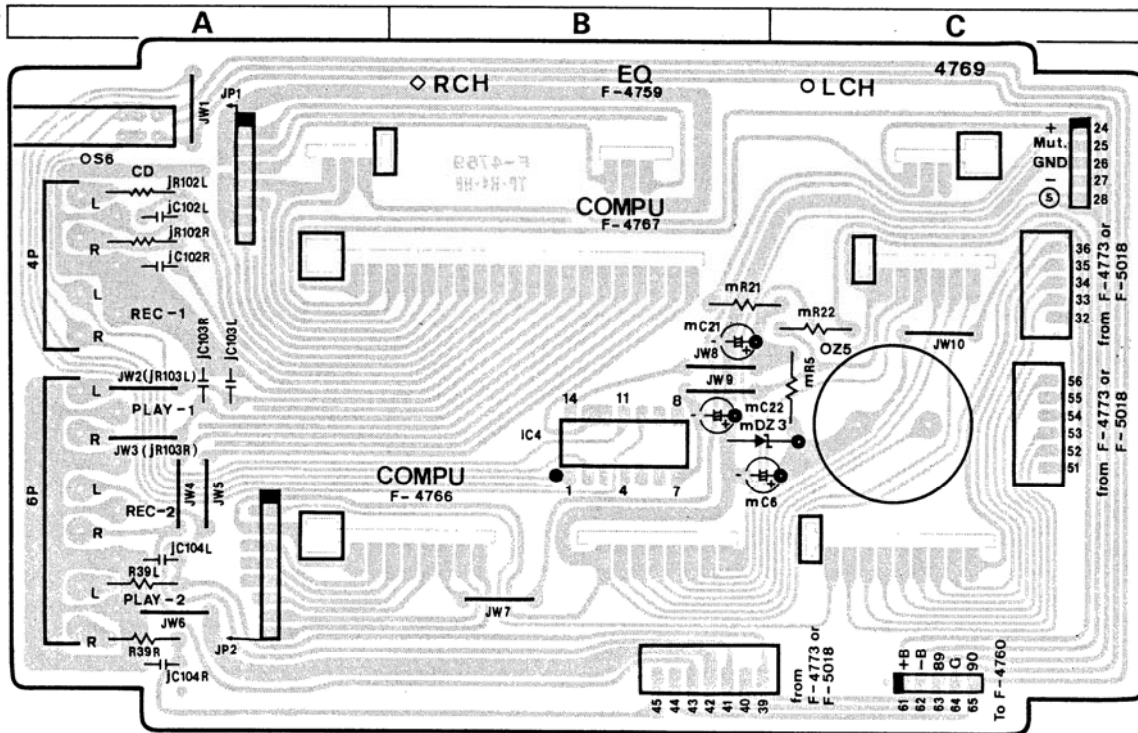

### Parts List

Parts No.	Stock No.	Description
• Zener Diode mDZ3	46100900 or 46101000	05Z5.1-X 05Z5.1-Y
△ mR5	46229700	390Ω 1/2W N.I.R.
• IC oIC4	46255000 or 48056800	LC4066BH LC4966

Parts No.	Stock No.	Description
oS6	46670600	Push SW., DECK SELECTOR
oZ3	46546800	6P Terminal Board, TAPE-1 (PLAY)•TAPE-2
oZ6	46371500	4P Terminal Board, CD/AUX• TAPE-1 (REC)

## 2-7. F-4770 COMPU SELECTOR Jack Board

Component Side

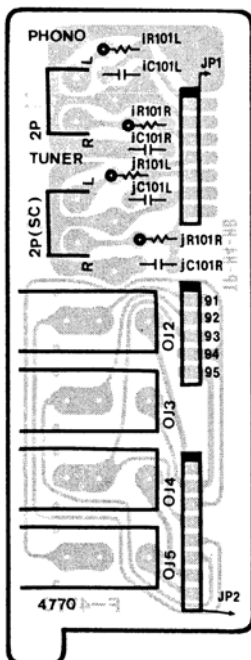

### Parts List

Parts No.	Stock No.	Description
oJ2	46547200	Jack, PHONO (COMPU SELECTOR)
oJ3	46547200	Jack, TUNER (COMPU SELECTOR)
oJ4	46547200	Jack, CD (COMPU SELECTOR)
oJ5	46547200	Jack, TAPE-1 (COMPU SELECTOR)
oZ2	46438100	2P Terminal Board, PHONO
oZ7	46363700	2P Terminal Board, TUNER

2-8. F-4773 Tone Control & BALANCE Volume Board  
Component Side

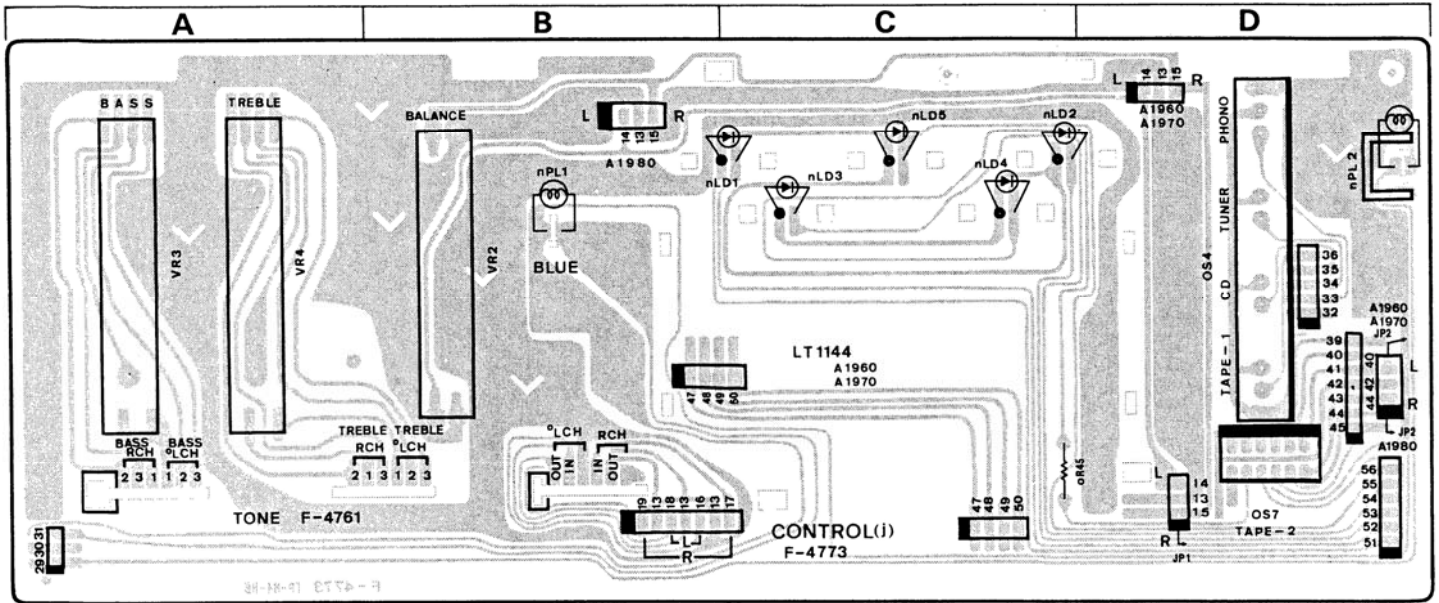

Parts List

Parts No.	Stock No.	Description
jVR2	48171100	250kΩ (W) V.R., BALANCE
jVR3	48171200	50kΩ (C) V.R., BASS
jVR4	48171200	50kΩ (C) V.R., TREBLE
•LED		
nLD1	48172100	BR3447S
nLD2	48172100	BR3447S
nLD3	48172100	BR3447S

Parts No.	Stock No.	Description
nLD4	48172100	BR3447S
nLD5	48172100	BR3447S
nPL1	48191900	12V 0.15A Pilot Lamp
nPL2	46286600	12V 0.15A Pilot Lamp
oS4	48178600	Push SW., PHONO•TUNER• CD/AUX•TAPE-1
oS7	46556300	Push SW., REMOTE CONT./TAPE-2

2-9. F-4774 VOLUME Control & LOUDNESS SW. Board  
Component Side

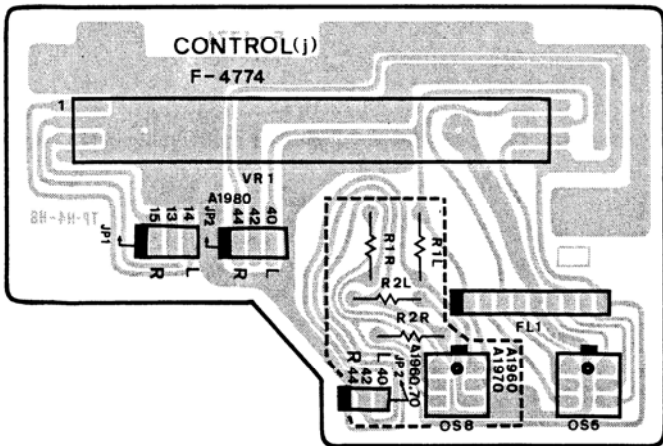

Parts List

Parts No.	Stock No.	Description
jFL1	48172000	CR Module (TCB09T0009)
jVR1	48171000	150kΩ (B) V.R., VOLUME
oS5	48183000	Push SW., LOUDNESS





Parts List <F-4778>

Parts No.	Stock No.	Description
ΔKR51	46229400	220Ω 1/2W N.I.R.
ΔKR101	46248100	10Ω 1/2W N.I.R.
ΔKR102	46248100	10Ω 1/2W N.I.R.
oS1	48170900	Push SW., SPEAKERS
oS2	46414000	Push SW., Mute SW. (POWER)
oS3	46360800	Push SW., Mute SW. (POWER)
oJ1	46265700	Jack, PHONES
oZ4	46947500	8P Terminal Board, SPEAKERS
ΔpC1	46425800	0.01μF 400V C.C.
Δ	or 46943200	0.01μF 400V C.C.
Δ	or 48186700	0.01μF 400V C.C.

Parts No.	Stock No.	Description
ΔpF1	07189000	4.0A 250V Fuse, (120V) <XX-UL-CSA>
Δ	07188600	2.0A 250V Fuse, (220V/240V) <XX>- (120V/220V/240V) <XX-V>
Δ	07184800	1.25A 250V Fuse, (220V/240V) <EU-BS-AS>
ΔpF2	07188600	2.0A 250V Fuse, (120V/220V/240V) <XX-V>
ΔpS11	46364300	Push SW., POWER

3. OTHER PARTS

3-1. Front View

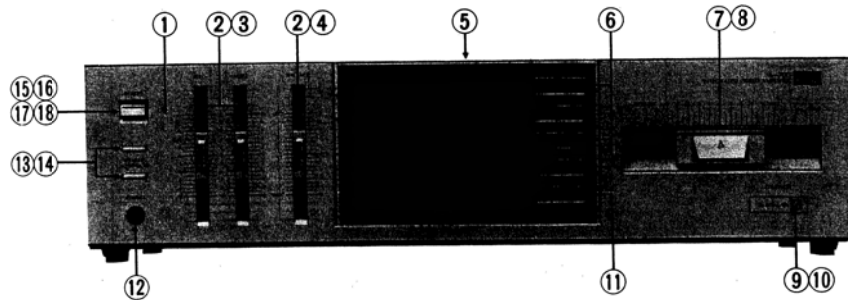

Parts List <Front View>

Parts No.	Stock No.	Description
1	47796700	Front Panel Ass'y for A-700 Silver Model <XX-XX-V-UL-EU-BS-AS>
	47796600	Front Panel Ass'y for A-700 Black Model <XX-XX-V-UL-EU-BS-AS>
	47866600	Front Panel Ass'y for A-700 Silver Model <CSA>
	47866700	Front Panel Ass'y for A-700 Black Model <CSA>
	47884800	Front Panel Ass'y for A-730
	47884900	Front Panel Ass'y for CLASSIQUE A-730
2	47732900	Slide Knob, BASS-TREBLE-BALANCE
3	48171200	50kΩ(C) Slide V.R., BASS-TREBLE
4	48171100	250kΩ Slide V.R., BALANCE
5	47874500	Bonnet for A-700 Silver Model
	47874600	Bonnet for A-700 Black Model-A-730-CLASSIQUE A-730
6	48178600	Push SW., PHONO-TUNER-CD/AUX TAPE-1
7	47761400	Knob Ass'y, VOLUME for A-700 Silver Model
	47761500	Knob Ass'y, VOLUME for A-700 Black Model-A-730-CLASSIQUE A-730

Parts No.	Stock No.	Description
8	48171000	150kΩ(B) V.R., VOLUME
9	47763400	Push Knob, LOUDNESS for A-700 Silver Model
	47763500	Push Knob, LOUDNESS for A-700 Black Model-A-730-CLASSIQUE A-730
10	48183000	Push SW., LOUDNESS
11	46556300	Push SW., REMOTE CONT./TAPE-2
12	46265700	Jack, PHONES
13	47716800	Push Knob, SPEAKERS for A-700 Silver Model
	07911000	Push Knob, SPEAKERS for A-700 Black Model-A-730-CLASSIQUE A-730
14	48170900	Push SW., SPEAKERS
15	47746800	Push Knob, POWER for A-700 Silver Model
	47746900	Push Knob, POWER for A-700 Black Model-A-730-CLASSIQUE A-730
Δ16	46364300	Push SW., POWER
17	46414000	Push SW., Mute SW.
18	46360800	Push SW., Mute SW.

3-2. Top View

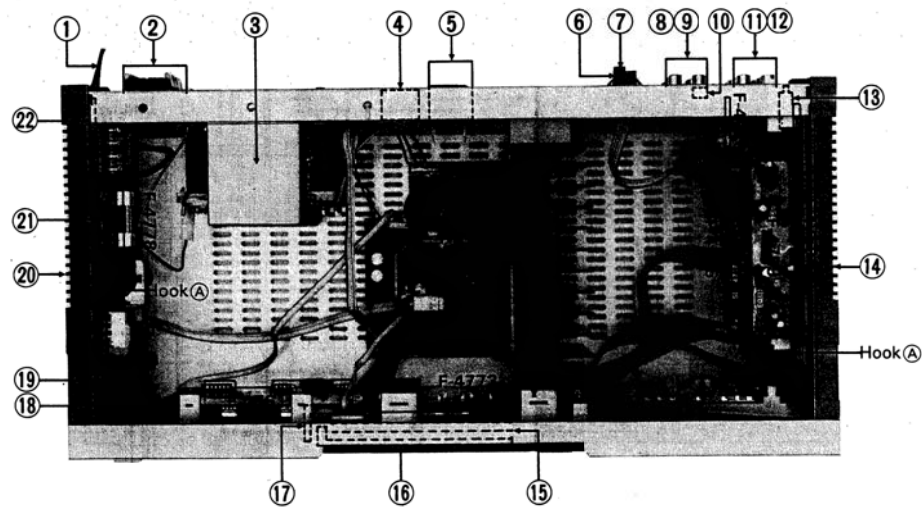

Parts List <Top View>

Parts No.	Stock No.	Description	Parts No.	Stock No.	Description
Δ1	38004700	Power Supply Cord <XX-XX-V-UL>	12	46546800	6P Terminal Board, TAPE-1 (PLAY) TAPE-2
Δ	48187800	Power Supply Cord <CSA>	13	46670600	Push SW., DECK SELECTOR
Δ	38004500	Power Supply Cord <EU>	14	47768700	Right Side Panel Ass'y for A-700 Silver Model
Δ	38004300	Power Supply Cord <BS>		47874800	Right Side Panel Ass'y for A-700 Black Model-A-730-CLASSIQUE A-730
Δ	07204200	Power Supply Cord <AS>	15	47796400	Illumination Plate
2	46947500	8P Terminal Board, SPEAKERS	16	47796300	Display Plate
Δ3	15020001	Power Transformer <XX>	17	47822400	Illumination Holder
Δ	15020002	Power Transformer <UL-CSA>	18	47763900	Joint Shaft (1), POWER
Δ	15020005	Power Transformer <EU-BS-AS>	19	07934000	Joint Shaft (2), POWER
Δ	15020009	Power Transformer <XX-V>	20	47768800	Left Side Panel Ass'y for A-700 Silver Model
Δ4	48175200	Voltage Selector <XX-V>		47874900	Left Side Panel Ass'y for A-700 Black Model-A-730-CLASSIQUE A-730
Δ	07204700	Slide SW., Voltage Selector <EU-BS-AS>	Δ21	07189000	4.0A 250V Fuse, (120V) <XX-UL-CSA>
Δ5	46360100	AC Outlet <XX-XX-V-UL>	Δ	07188600	2.0A 250V Fuse, (220V/240V) <XX>- (120V/220V/240V) <XX-V>
Δ	48184800	AC Outlet <CSA>	Δ	07184800	1.25A 250V Fuse, (220V/240V) <EU-BS-AS>
Δ	46161000	AC Outlet <EU>	22	47770900	Power Supply Cord Cover
Δ	46364800	AC Outlet <BS>			
Δ	46580600	AC Outlet <AS>			
6	48197700	5P Terminal Board (with wire), REMOTE CONTROL			
7	22301510	GND Terminal			
8	46438100	2P Terminal Board, PHONO			
9	46363700	2P Terminal Board, TUNER			
10	46547200	Jack, COMPU SELECTOR			
11	46371500	4P Terminal Board, CD/AUX TAPE-1 (REC)			

**SCHEMATIC DIAGRAM**

• Design and specifications subject to change without notice for improvement.  
 • La présentation et les spécifications sont susceptibles d'être modifiées sans préavis par suites d'améliorations éventuelles.  
 • Änderungen, die dem technischen Fortschritt dienen, bleiben vorbehalten.

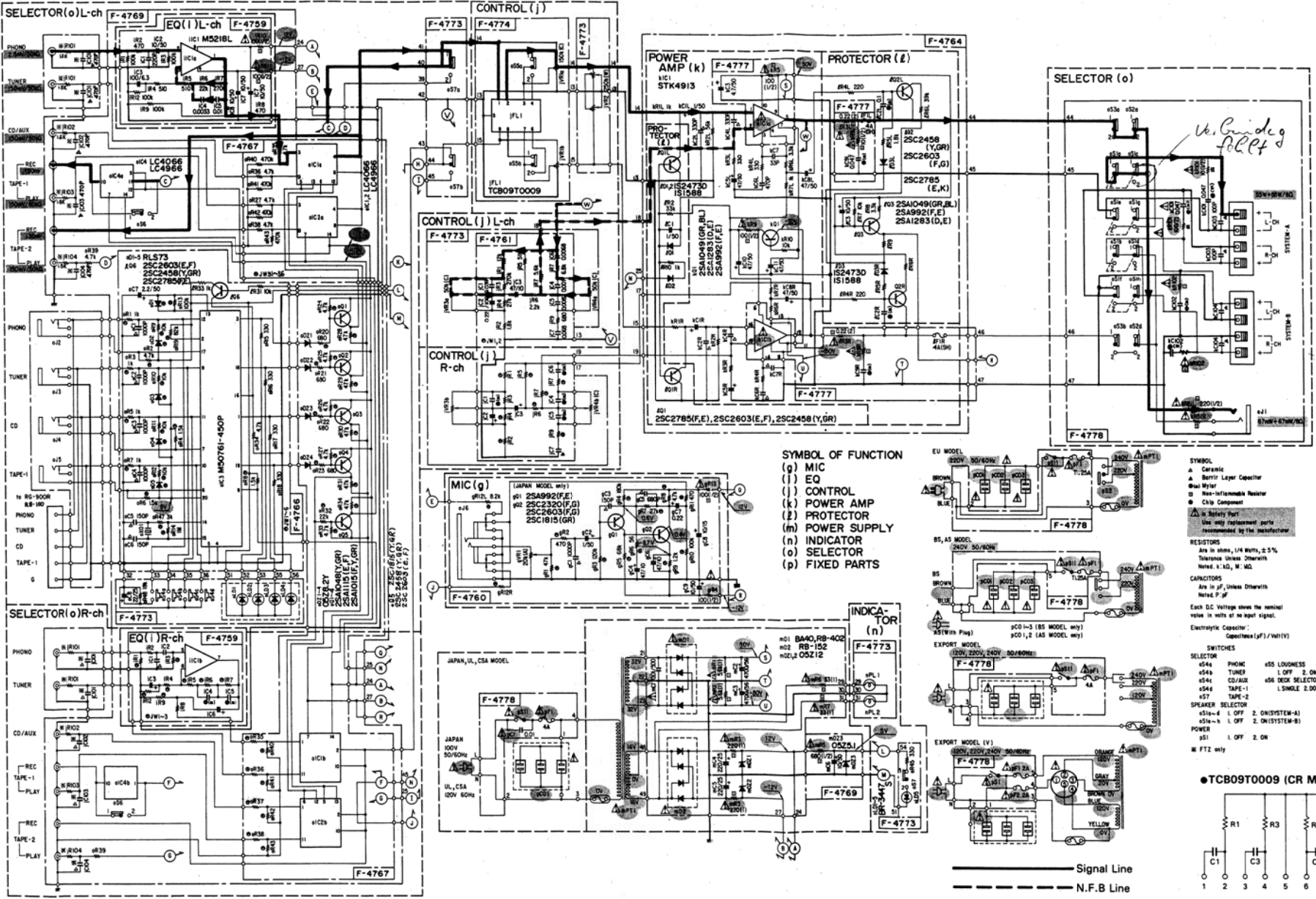

**SYMBOL OF FUNCTION**  
 (g) MIC  
 (j) EQ  
 (k) CONTROL  
 (l) POWER AMP  
 (m) PROTECTOR  
 (n) POWER SUPPLY  
 (o) INDICATOR  
 (p) SELECTOR  
 (q) FIXED PARTS

**SYMBOL**  
 Δ Ceramic  
 A Barrier Layer Capacitor  
 ⊗ Mylar  
 ⊕ Non-ferromagnetic Resistor  
 ● Chip Component  
 ⚠ Safety Part  
 Use only replacement parts recommended by the manufacturer

**RESISTORS**  
 Are in ohms, 1/4 Watt, ±5%  
 Tolerance Unless Otherwise Noted: K, Ω, M, ML

**CAPACITORS**  
 Are in μF, Unless Otherwise Noted: pF

Each D.C. Voltage shows the nominal value in volts at no signal.

Electrolytic Capacitor:  
 Capacitance (μF)/V(IV)

**SWITCHES**  
 SELECTOR  
 s54a PHONO s55 LOUDEST  
 s54b TUNER L OFF 2 ON  
 s54c CD/AUX s56 DECK SELECTOR  
 s54d TAPE-1 L SINGLE 2 DOUBLE  
 s57 TAPE-2  
 SPEAKER SELECTOR  
 s53a-1 L OFF 2 ON (SYSTEM-A)  
 s53a-2 L OFF 2 ON (SYSTEM-B)  
 POWER  
 s51 L OFF 2 ON  
 \* FT2 only

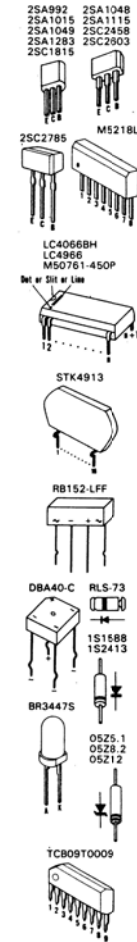

●TCB09T0009 (CR Module)

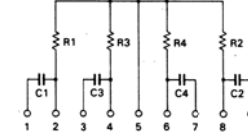

— Signal Line  
 - - - N.F.B Line

1  
2  
3  
4  
5

## 5. INTERIOR BLOCK DIAGRAM OF IC

### •STK4913 (Power Amp. IC)

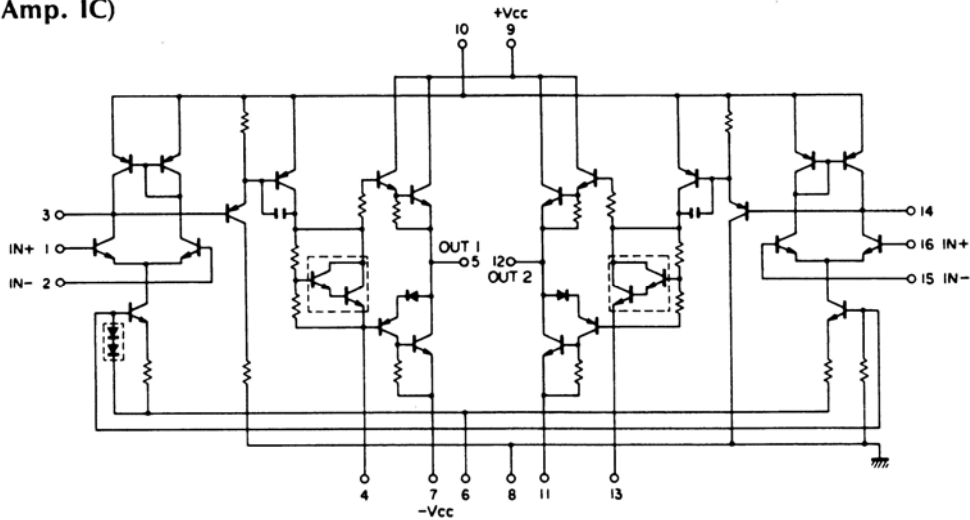

### •LC4966/LC4066BH (Quad Bi-lateral SW. IC)

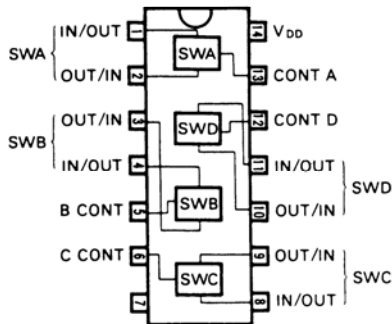

### •M5218L (Audio Pre Amp. IC)

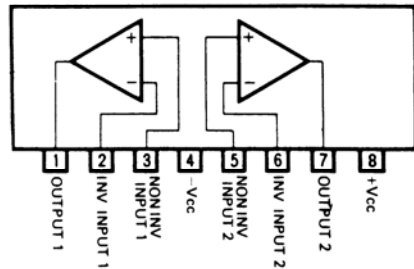

## 6. MAIN PARTS REPLACEMENT

### A. Bonnet (See Fig. 6-1)

- 1) Remove two screws (S<sub>A</sub>).
- 2) Pull the rear side of the bonnet to remove the hooks and then remove bonnet.

Fig. 6-1

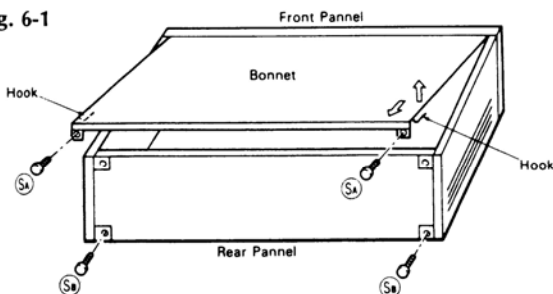

### B. Bottom Plate

- 1) Remove two screws (S<sub>B</sub>) (Fig. 6-1).
- 2) Pull the rear side of the bonnet to remove the hooks and then remove bottom plate.

### C. Side Panel L (R) (See 3-2. Top View on Page 8 & Fig. 6-2)

- 1) Remove bonnet and bottom plate.
- 2) Push up hooks (A) (upper side & bottom side) of side panel ass'y and separate F-4778 (or F-4769) board from side panel ass'y.
- 3) Shift the position of the side panel L (R) 1.5cm in the arrow direction (1).
- 4) Remove the hooks (2) of the side panel from front panel and then pull it the arrow direction (3) to remove the side panel L (R).

Fig. 6-2

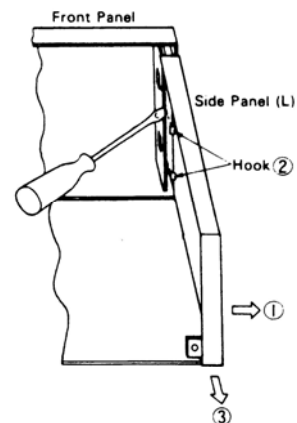

## 5. INTERIOR BLOCK DIAGRAM OF IC

### •STK4913 (Power Amp. IC)

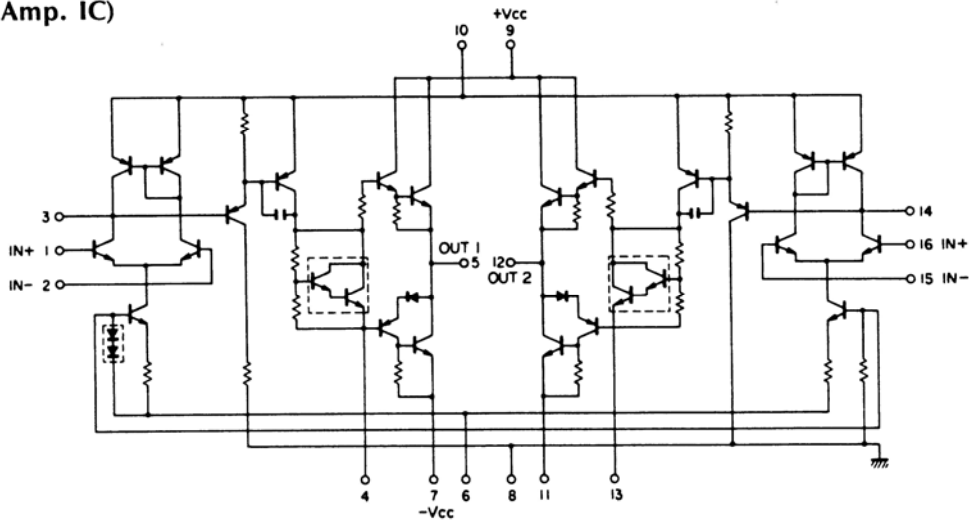

### •LC4966/LC4066BH (Quad Bi-lateral SW. IC)

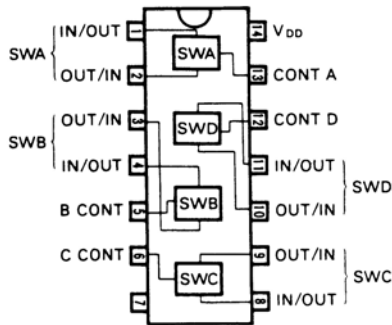

### •M5218L (Audio Pre Amp. IC)

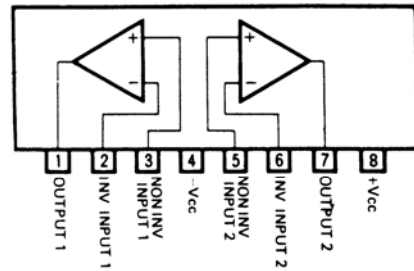

## 6. MAIN PARTS REPLACEMENT

### A. Bonnet (See Fig. 6-1)

- 1) Remove two screws (S<sub>a</sub>).
- 2) Pull the rear side of the bonnet to remove the hooks and then remove bonnet.

Fig. 6-1

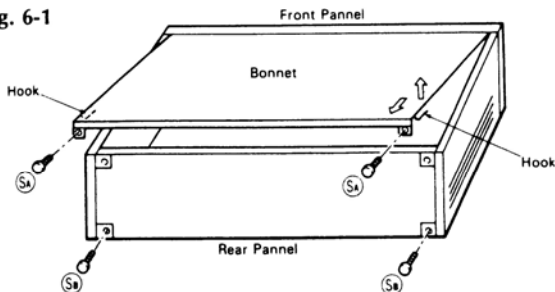

### B. Bottom Plate

- 1) Remove two screws (S<sub>b</sub>) (Fig. 6-1).
- 2) Pull the rear side of the bonnet to remove the hooks and then remove bottom plate.

### C. Side Panel L (R) (See 3-2. Top View on Page 8 & Fig. 6-2)

- 1) Remove bonnet and bottom plate.
- 2) Push up hooks (A) (upper side & bottom side) of side panel ass'y and separate F-4778 ( or F-4769) board from side panel ass'y.
- 3) Shift the position of the side panel L (R) 1.5cm in the arrow direction (1).
- 4) Remove the hooks (2) of the side panel from front panel and then pull it the arrow direction (3) to remove the side panel L (R).

Fig. 6-2

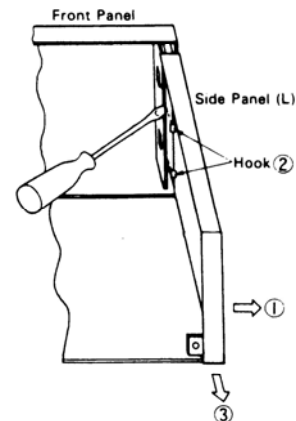



## 7. PACKING LIST

Parts No.	Stock No.	Description
1	47859900	Vinyl Cover
2	47764600	Styrofoam Packing
3	47796000	Carton Case for A-700 Silver Model <XX-UL-CSA-EU-BS-AS>
	47795900	Carton Case for A-700 Black Model <XX-UL-CSA-EU-BS-AS>
	47795800	Carton Case for A-700 Silver Model <XX-V>
	47795700	Carton Case for A-700 Black Model <XX-V>
	47888100	Carton Case for CLASSIQUE A-730
	47887800	Carton Case for A-730

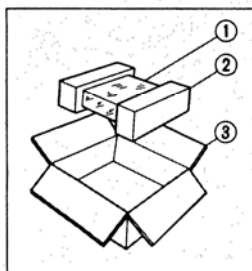

## 8. ACCESSORY LIST

Stock No.	Description
46967300	Operating Instruction for A-700
46968000	Operating Instruction for A-730
46967400	Operating Instruction for CLASSIQUE A-730

•Note: XX-V <EXPORT (V)> Standard Version with Inner Voltage Selector.  
("V" mark is indicated on the carton case.)



SANSUI ELECTRIC CO., LTD.:

SANSUI ELECTRONICS CORPORATION:

SANSUI ELECTRONICS (U.K.) LTD.:  
SANSUI ELECTRONICS G.M.B.H.:

14-1, Izumi 2-chome, Suginami-ku, Tokyo 168 Japan  
PHONE: (03) 324-8891/TELEX: 232-2076 (International Division)  
1250 Valley Brook Ave. Lyndhurst, N.J. 07071 U.S.A.  
17150 South Margay Ave. Carson, California 90746 U.S.A.  
3036 Koapaka Street, Honolulu, Hawaii 96819 U.S.A.  
Unit 10A, Lyon Industrial Estate, Rockware Avenue, Geenford, Middx UB6, OAA, England  
Pau Ehrich Strasse 8, 6074 Rödermark 2, West Germany